

Filter module VMF, differential pressure sensor VMO, fine-adjusting valve VMV

OPERATING INSTRUCTIONS

· Edition 05.25 · EN · 03250879



CONTENTS

1 Safety	1
2 Checking the usage	2
3 Installation	2
4 Tightness test	3
5 Commissioning	4
6 Maintenance	4
7 Accessories	5
8 Technical data	7
9 Pressure units	8
10 Designed lifetime	8
11 Logistics	8
12 Certification	9

1 SAFETY

1.1 Read the operating instructions before use



Please read through these instructions carefully before installing or operating. Following the installation, pass the instructions on to the operator. This unit must be installed and commissioned in accordance with the regulations and standards in force. These instructions can also be found at www.docuthek.com.

1.2 Explanation of symbols

1, 2, 3, a, b, c = Action

→ = Instruction

1.3 Liability

We will not be held liable for damage resulting from non-observance of the instructions and non-compliant use.

1.4 Safety instructions

Information that is relevant for safety is indicated in the instructions as follows:

⚠ DANGER

Indicates potentially fatal situations.

⚠ WARNING

Indicates possible danger to life and limb.

⚠ CAUTION

Indicates possible material damage.

All interventions may only be carried out by qualified gas technicians. Electrical interventions may only be carried out by qualified electricians.

1.5 Conversion, spare parts

All technical changes are prohibited. Only use OEM spare parts.

2 CHECKING THE USAGE

Intended use

valVario filter module VMF, differential pressure sensor VMO and fine-adjusting valve VMV for installation in gas control and safety systems in the fields of industrial and commercial gas heat generation.

VMF

with replaceable filter pad insert to protect against soiling of downstream appliances.

VMO

with replaceable differential pressure orifice plate. For use as a differential pressure sensor.

VMV

Fine-adjusting valve for presetting the gas or air flow rate to gas burners or gas appliances.

This function is only guaranteed when used within the specified limits – see page 7 (8 Technical data). Any other use is considered as non-compliant.

2.1 Type code

VMF	Filter module
1-3	Sizes
–	Without flange
10-65	Inlet and outlet flange nominal size
R	Rp internal thread
N	NPT internal thread
F	Flange to ISO 7005
05	p_u max. 500 mbar
P	Screw plugs
M	Test nipple

2.2 Type code

VMO	Differential pressure sensor
1-3	Sizes
10-65	Inlet and outlet flange nominal size
R	Rp internal thread
N	NPT internal thread
F	Flange to ISO 7005
05	p_u max. 500 mbar
M	Test nipple
04-54	Orifice diameter in mm

2.3 Type code

VMV	Fine-adjusting valve
1-3	Sizes
10-65	Inlet and outlet flange nominal size
R	Rp internal thread
N	NPT internal thread
F	Flange to ISO 7005
05	p_u max. 500 mbar
P	Screw plugs
M	Test nipple

2.4 Part designations

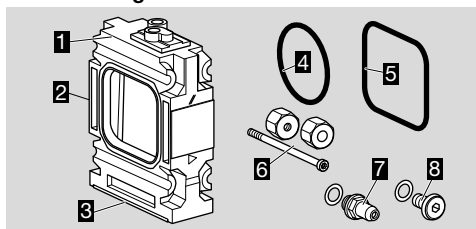

- 1 Housing
- 2 Type label
- 3 Baseplate
- 4 O-ring
- 5 Double block seal
- 6 Connection parts (2 x)
- 7 Pressure test nipple
- 8 Sealing plug

2.5 Type label

Inlet pressure p_u and ambient temperature: see type label.

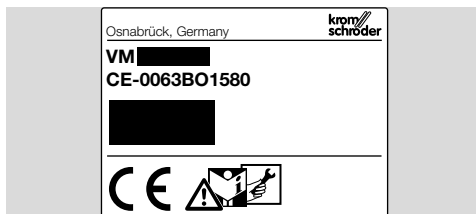

3 INSTALLATION

⚠ CAUTION

Incorrect installation

Please observe the following to ensure that the unit is not damaged during installation and operation:

- Dropping the device can cause permanent damage. In this event, replace the entire device and associated modules before use.
- Installation position: install the VMF with the baseplate pointing downwards or sideways, otherwise dirt can collect in the housing when replacing the filter pad. The VMV can be installed as required; when fitting to pressure regulator VAD, VAG or VAV, the baseplate must be facing the same direction as the regulator body. VMO can be installed as required.
- Installation position when using valVario controls: VMF is fitted upstream of the control, VMV is fitted downstream of the control. When used as a restricting orifice, the

VMO is fitted downstream of the control.

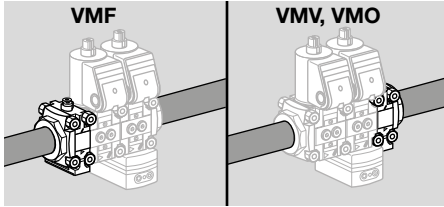

- Installation position with inlet and outlet flanges: VMF, VMV and VMO may be inserted at any position in the pipework. When used as a differential pressure sensor, the length of the inlet and outlet section of the VMO must be ≥ 5 DN.

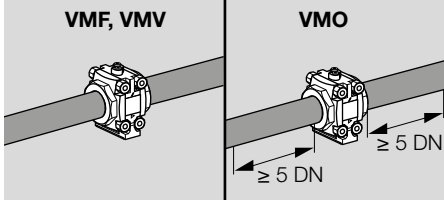

- The housing must not be in contact with masonry, minimum clearance 20 mm (0.79").
- Sealing material and thread cuttings must not be allowed to get into the housing.
- A filter must be installed upstream of every system.
- Ensure that there is sufficient space for installation and adjustment.
- Do not store or install the unit in the open air.

CAUTION

Incorrect installation

Please observe the following to ensure that the unit is not damaged during installation and operation:

- Only secure the device by holding the octagon on the flange with a suitable spanner. Risk of external leakage.

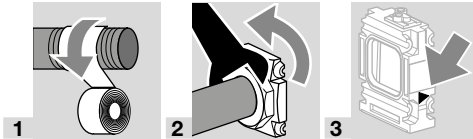

- Both O-rings or the O-ring and double block seal must be fitted.

WARNING

Risk of leakage.

Please note the following:

- If VMF, VMO or VMV has been delivered with two flanges and is subsequently attached to a valVario control, a double block seal must be used instead of the O-ring. The double block seal must be ordered separately, see accessories, seal set for sizes 1–3.

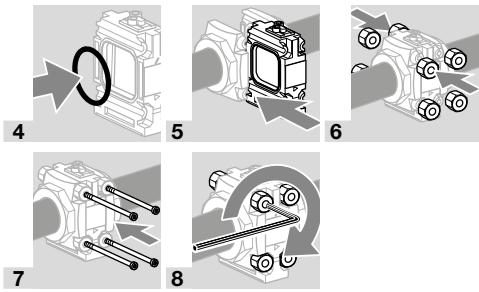

VMV

- If the fine-adjusting valve VMV is fitted downstream of a pressure regulator VAD, VAG or VAV, a differential pressure orifice with rubber seals **G** must be inserted at the outlet of the pressure regulator.

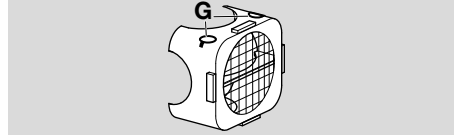

4 TIGHTNESS TEST

- 1 To be able to check the tightness, shut off the downstream pipeline close to the VMF, VMO, VMV.

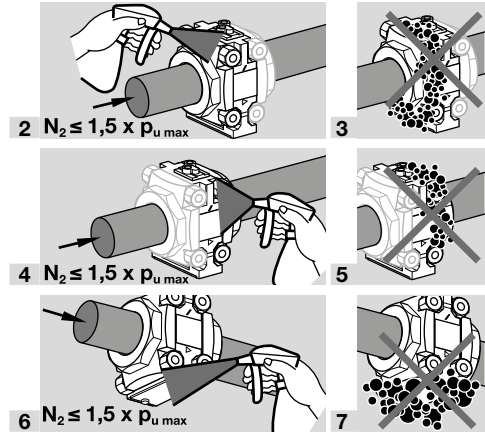

- 8 Tightness OK: open the pipeline.
- Pipeline leaking: check O-rings. When installing on a valVario valve or pressure regulator, check the O-ring and, if fitted, the double block seal.
 - Unit leaking: dismantle the VMF, VMO or VMV and return it to the manufacturer.

5 COMMISSIONING

5.1 VMV

Setting the flow rate

→ At the factory, the fine-adjusting valve VMV is adjusted for maximum flow rate (100%).

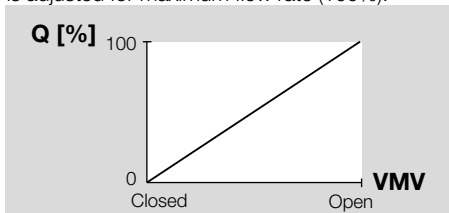

⚠ CAUTION

Please observe the following to ensure that the unit is not damaged during operation:

– Do not overturn the adjusting screw, as the fine-adjusting valve then can no longer be adjusted.

→ The VMV can be adjusted from two sides.

→ 2.5 mm Allen key.

1 Set the required flow rate.

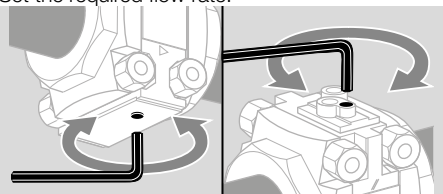

2 Check the VMV for tightness – see page 3 (4 Tightness test).

5.2 VMO

Replacing the differential pressure orifice plate

→ Differential pressure orifice plates – see accessories.

→ 2.5 mm Allen key.

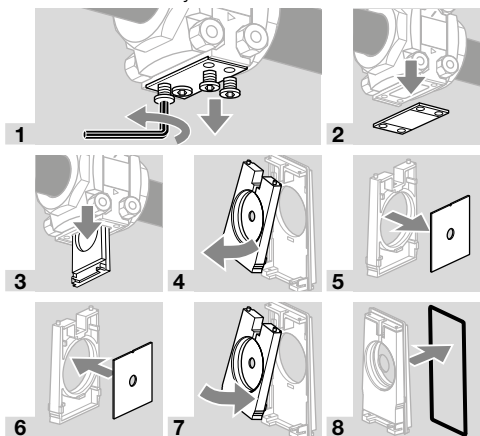

9 Insert the new sealing ring (included in the delivery) when fitting the new differential pressure

orifice plate. The sealing ring may be greased lightly, e.g. with Klüber Nontrop ZB91.

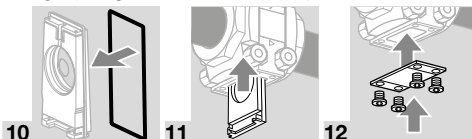

10

11

12

13 Screw the cover into place.

14 Check the VMO for tightness – see page 3 (4 Tightness test).

6 MAINTENANCE

⚠ CAUTION

In order to ensure smooth operation:

– Check the VM for tightness annually, or every six months if operated with biogas.

VMF: replacing the filter pad

→ If the flow rate is correct, check for tightness – see page 3 (4 Tightness test).

→ If the flow rate has dropped, replace the filter pad.

1 Disconnect the system from the electrical power supply.

2 Shut off the gas supply.

→ 2.5 mm Allen key.

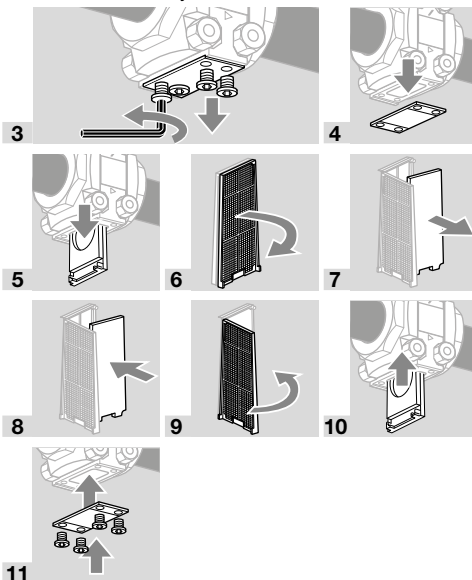

11

12 Screw the cover into place.

13 Check the VMF for tightness – see page 3 (4 Tightness test).

7 ACCESSORIES

7.1 Differential pressure orifice plate

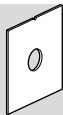

For installing in the bracket of differential pressure sensor VMO. The hole diameter is engraved on the plate. Supply including the new seal for the baseplate.

Orifice	Hole dia. [mm]	Order No.
VMO1 D4 /B	4	74923803
VMO1 D5 /B	5	74923804
VMO1 D6 /B	6	74923805
VMO1 D8 /B	8	74923806
VMO1 D10 /B	10	74923807
VMO1 D12 /B	12	74923808
VMO1 D14 /B	14	74923809
VMO1 D16 /B	16	74923810
VMO1 D18 /B	18	74923811
VMO1 D20 /B	20	74923812
VMO1 Dx /B*	xx*	74923813
VMO2 D16 /B	16	74923814
VMO2 D20 /B	20	74923815
VMO2 D24 /B	24	74923816
VMO2 D28 /B	28	74923817
VMO2 D32 /B	32	74923818
VMO2 D34 /B	34	74923819
VMO2 D38 /B	38	74923820
VMO2 Dx /B	xx*	74923821
VMO 3 D38 /B	38	74926017
VMO 3 D42 /B	42	74926018
VMO 3 D46 /B	46	74926019
VMO 3 D50 /B	50	74926020
VMO 3 D54 /B	54	74926021
VMO 3 Dx /B	xx*	74926022

* Hole diameter on request.

7.1.1 Differential pressure

The actual differential pressures may deviate from the characteristic curves.

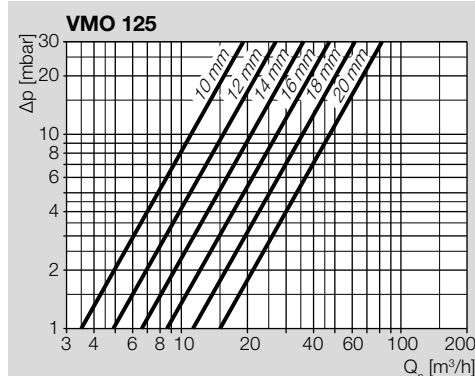
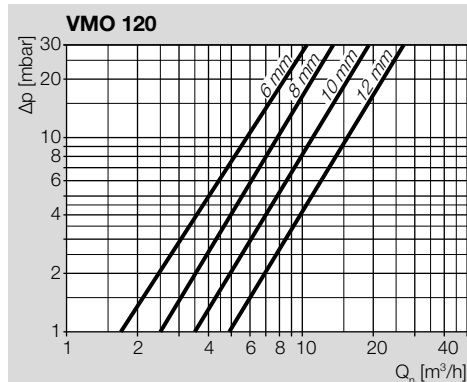
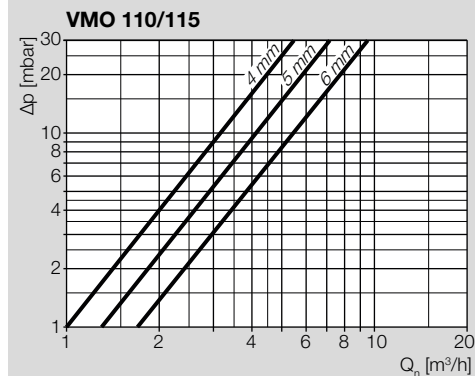

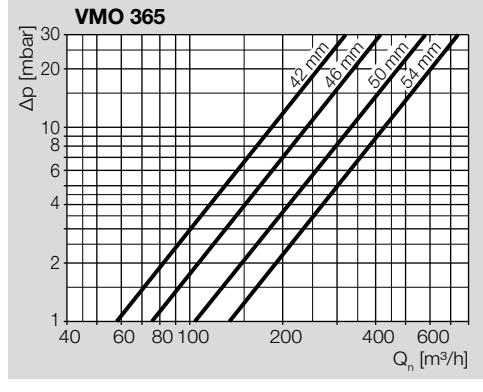
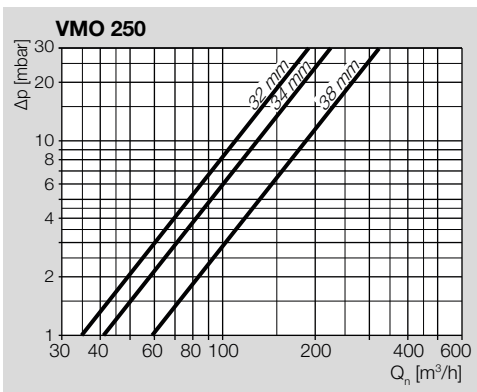
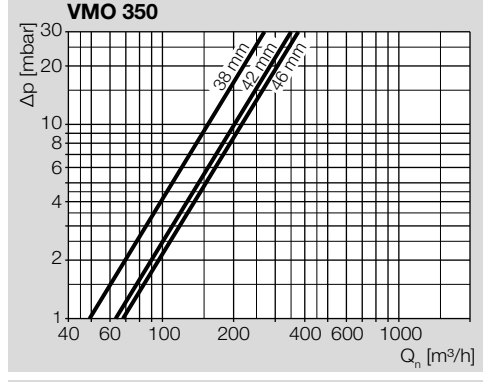
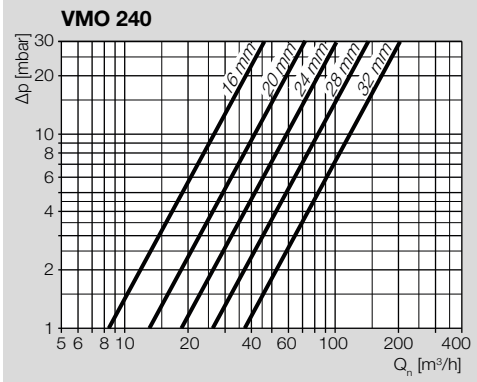
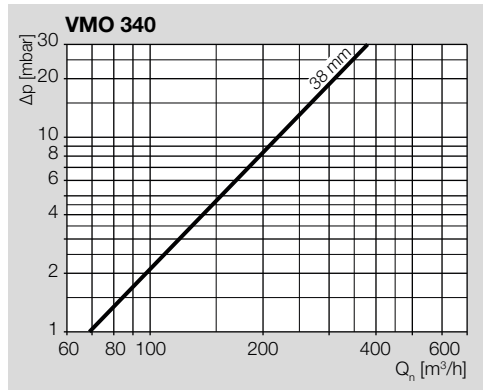
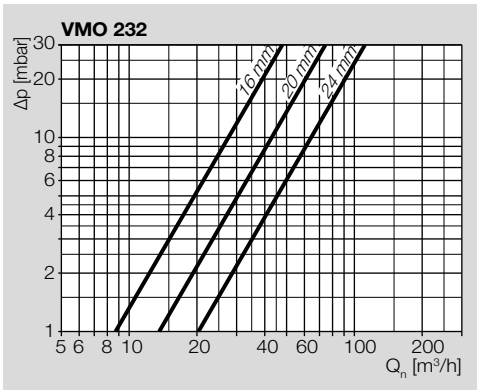

7.2 Seal set for sizes 1–3

When retrofitting accessories or a second valVario control or when servicing, we recommend replacing the seals.

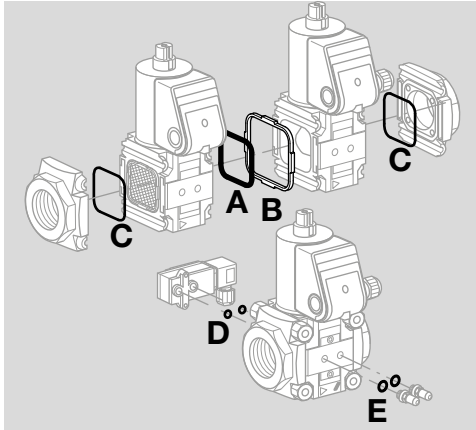

VAx 1–3

VA 1, Order No. 74921988,

VA 2, Order No. 74921989,

VA 3, Order No. 74921990.

Scope of delivery:

- A** 1 x double block seal,
- B** 1 x retaining frame,
- C** 2 x O-rings (flange),
- D** 2 x O-rings (pressure switch),

for test nipple/screw plug:

E 2 x sealing rings (flat sealing),

2 x profiled sealing rings.

VCx 1-3

VA 1, Order No. 74924978,

VA 2, Order No. 74924979,

VA 3, Order No. 74924980.

Scope of delivery:

- A** 1 x double block seal,
- B** 1 x retaining frame.

7.3 Seal set VMO/VMV

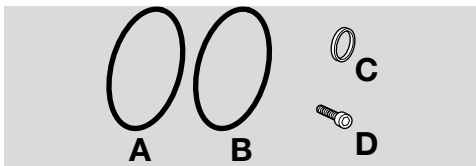

Seal set VMO/VMV 1 /B: 74924936

Seal set VMO/VMV 2 /B: 74924937

Seal set VMO/VMV 3 /B: 74926024

Scope of delivery:

- A** 1 x O-ring (baseplate)
- B** 1 x O-ring (restrictor insert)
- C** 2 x O-rings (sealing rings)
- D** 2 x or 4 x set screws

7.4 Filter pad set

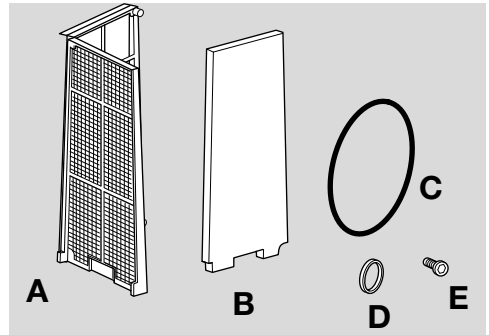

Filter pad set for size 1: Order No. 74923800

Filter pad set for size 2: Order No. 74923801,

Filter pad set for size 3: Order No. 74926023

Scope of delivery:

VMF 1–2:

- A** 1 x filter frame
- B** 10 x filter pads
- C** 10 x seals for the baseplate
- D** 2 x profiled sealing rings for 1/8" test nipple
- E** 2 x screws for securing the baseplate

VMF 3:

- A** 1 x filter frame
- B** 10 x filter pads
- C** 10 x 61x2 O-rings
- D** 2 x profiled sealing rings for 1/8" test nipple
- E** 4 x screws for securing the baseplate

8 TECHNICAL DATA

Gas types:

natural gas, LPG (gaseous), biogas (max. 0.1 %-by-vol. H₂S), hydrogen or air; other gases on request. The gas must be dry in all conditions and must not contain condensate.

Max. inlet pressure p_U:

500 mbar (7.25 psig).

Medium and ambient temperatures:

-20 to +60°C (-4 to +140°F), no condensation permitted.

Long-term use in the upper ambient temperature range accelerates the ageing of the elastomer materials and reduces the service life (please contact manufacturer).

Storage temperature: -20 to +40°C (-4 to +104°F).

Housing: aluminium.

Connection flanges:

with internal thread: Rp to ISO 7-1, NPT to ANSI/ASME,

with ISO flange: DN 40 and DN 50 to ISO 7005.

VMV: air flow rate Q for a pressure loss of $\Delta p = 1$ mbar:

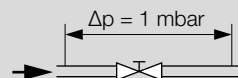

	$Q_{\min.}$ [m ³ /h]	$Q_{\max.}$ [m ³ /h]
VMV 110	0.2	9.1
VMV 115	0.2	12.5
VMV 120, VMV 125	0.2	19.4
VMV 225	0.6	36.1
VMV 232–VMV 250	0.6	51.4
VMV 340	0.3	68
VMV 350	0.3	60.1
VMV 365	0.3	64.8

VMV: air flow rate Q for a pressure loss of $\Delta p = 10$ mbar:

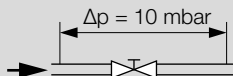

	$Q_{\min.}$ [m ³ /h]	$Q_{\max.}$ [m ³ /h]
VMV 110	0.4	22.9
VMV 115	0.4	31.4
VMV 120, VMV 125	0.4	48.8
VMV 225	1.5	91
VMV 232–VMV 250	1.5	129.6
VMV 340	0.3	68
VMV 350	0.3	60.1
VMV 365	0.3	64.8

VMF: air flow rate Q for pressure loss Δp :

	Air flow rate Q [m ³ /h] for	
	$\Delta p = 1$ mbar	$\Delta p = 10$ mbar
VMF 110	4.9	15.5
VMF 115	7	22.1
VMF 120	13	41.2
VMF 125	16	50.7
VMF 225	23.2	73.5
VMF 232	31.9	101
VMF 240	38.3	121
VMF 250	41.1	130
VMF 340	61	194
VMF 350	64	203
VMF 365	68	218

9 PRESSURE UNITS

mbar	Pa	kPa	"WC
1	100	0.1	0.4

10 DESIGNED LIFETIME

This information on the designed lifetime is based on using the product in accordance with these

operating instructions. Once the designed lifetime has been reached, safety-relevant products must be replaced.

Designed lifetime (based on date of manufacture) in accordance with EN 13611, EN 161 for VM 1 to VM 2: 10 years.

You can find further explanations in the applicable rules and regulations and on the afecor website (www.afecor.org).

This procedure applies to heating systems. For thermoprocessing equipment, observe local regulations.

11 LOGISTICS

Transport

Protect the unit from external forces (blows, shocks, vibration).

Transport temperature: see page 7 (8 Technical data).

Transport is subject to the ambient conditions described.

Report any transport damage on the unit or packaging without delay.

Check that the delivery is complete.

Storage

Storage temperature: see page 7 (8 Technical data).

Storage is subject to the ambient conditions described.

Storage time: 6 months in the original packaging before using for the first time. If stored for longer than this, the overall service life will be reduced by the corresponding amount of extra storage time.

Packaging

The packaging material is to be disposed of in accordance with local regulations.

Disposal

Components are to be disposed of separately in accordance with local regulations.

12 CERTIFICATION

12.1 Certificate download

Certificates – see www.docuthek.com

12.2 Declaration of conformity



We, the manufacturer, hereby declare that the products VMF/VMV/VMO with product ID No. CE-0063BO1580 comply with the requirements of the listed Directives and Standards.

Directives:

- 2011/65/EU – RoHS II
- 2015/863/EU – RoHS III

Regulation:

- (EU) 2016/426 – GAR

Standards:

- EN 13611: 2019, external tightness

The relevant product corresponds to the tested type sample.

The production is subject to the surveillance procedure pursuant to Regulation (EU) 2016/426 Annex III paragraph 3.

Elster GmbH

12.3 UKCA certified



Gas Appliances (Product Safety and Metrology etc. (Amendment etc.) (EU Exit) Regulations 2019)
EN 13611: 2019, external tightness

12.4 REACH Regulation

The device contains substances of very high concern which are listed in the Candidate List of the European REACH Regulation No. 1907/2006. See Reach list HTS at www.docuthek.com.

12.5 China RoHS

Directive on the restriction of the use of hazardous substances (RoHS) in China. Scan of the Disclosure Table China RoHS2, see certificates at www.docuthek.com.

FOR MORE INFORMATION

The Honeywell Thermal Solutions family of products includes Honeywell Combustion Safety, Eclipse, Exothermics, Hauck, Kromschöder and Maxon. To learn more about our products, visit ThermalSolutions.honeywell.com or contact your Honeywell Sales Engineer.

Elster GmbH
Strotheweg 1, D-49504 Lotte
T +49 541 1214-0
hts.lotte@honeywell.com
www.kromschroeder.com

Global centralized service deployment coordination:
T +49 541 1214-365 or -555
hts.service.germany@honeywell.com

Translation from the German
© 2025 Elster GmbH

Honeywell
krom
schroder