

Lago Basic 0201 R V1

Heating module

Operating and Installation Instructions



Please observe the safety instructions and read through this manual carefully before commissioning the equipment.

Safety information

Power connection regulations

Please note the connection conditions specified by your local electrical power supply utility and the VDE regulations.

Your heating control system may be installed and serviced only by appropriately authorised specialists.

- ⚠ If the system is not installed properly, there is a risk of fatal or severe personal injury.

Warranty conditions

If the system is not installed, commissioned, serviced and repaired professionally, this will render the manufacturer's warranty null and void.

Important text passages

! Important information is highlighted with an exclamation mark.

- ⚠ This attention symbol is used to point out dangers in this manual.

Installation

Information on installation of the system is provided in Part 2 of this manual together with a connection diagram.

Description





Declaration of conformity



This device corresponds to the requirements of the relevant guidelines and standards provided the corresponding installation regulations and the manufacturer's instructions are complied with.











General Function

- Heating module in a cascade
- Control of return flow temperature increase using pump or mixer (depending on configuration)
- Control of a modulating heat generator by means of driving the air damper (function only in connection with a Manager)



General information	2	Functions	8
Safety information	2	Operation in the cascade	8
Power connection regulations	2	Modulation in the cascade	8
Warranty conditions	2	Operation of a single heat generator	9
Important text passages	2	Stand alone	9
Installation	2	Single HS with Manager via CAN BUS	9
Description	2	Modulation via air damper	9
Declaration of conformity	2	Frost protection function	10
General Function	2	Temperature monitor operation	10
Operation	4	Pump-controlled return flow temperature increase	10
Explanation of the operating elements	4	Mixer-controlled return flow temperature increase	10
Selection switch	4	EEPROM check	10
Rotary knob	4	Pump blocking protection	10
Button STL-test / Enter / Reset	4	Mixer motor blocking protection	10
Settings via DIP switch (rear side)	4	Delayed pump switch-off	10
Display (normal mode "Run")	5	Installation	11
Starting up	6	Assembly / Dismantling	11
Modifying set values	6	Electrical connection Controller	12
List of the User Set Values	6	System diagrams	13
Explanatory information	7	HS controller in cascade operation	13
Set values	7	Sensors	14
Settings via DIP switch (rear side)	8	Outdoor sensor AF 	14
		Immersion sensor KF  / SPF 	14
		Flow sensor VF 	14
		Sensor values / characteristic curve	15
		Errors	15
		Technical data	16

Explanation of the operating elements

Selection switch

- RUN Automatic mode
-  Standby (frost protection only)
burner OFF, pump OFF
-  1 Service 1 / Emerg-Mode (set value => °C )
Burner ON, Pump ON*)
Modulation: Burner On, Air damper CLOSE
-  1 + Prog button => Relay Test (=>Rotary knob)
-  2 Service 2 / Emerg-Mode (set value => °C )
- ⇒ 1/2/11/Mod = 2: Burner 1+2 ON, HS1 Pump ON*)
 - ⇒ 1/2/11/Mod = 11: Burner 2 ON, HS2 pump ON*)
 - ⇒ 1/2/11/Mod = m: Burner ON, Air damper OPEN
- BUS ID bus identification (boiler number)
- °C  in the case of fixed value: Flow / Return flow set
temperature in the case of control mode:
Maximum flow temperature
with cascade: Presettings via cascade
- controller
- °C  without function
-  in the case of return flow temperature increase
using mixer:
Mixer dynamics [K for 100% control]
Modulation in cascade: Air damper activation
time [s]
- °C  in the case of return flow temperature increase:
min. return flow temperature

⇒ 1/2/11/Mod heat generator stages
(1=single stage, 2=two-stage, 11=2HS, m=modulating)

*) Pump ON > [°C  +5K v 65°C]; OFF < [°C  -5K v 55°C]

Rotary knob

- Adjusting a set value

Button STL-test / Enter / Reset

STL-test (RT without effect) => By pressing > 1s
=>Burner on, for as long as button is pressed, display: HS-
Temp flashes (no function as mixer)

Enter (modify set values) => Selection of parameter for
adjustment (flashing); Save by pressing again
=> for temperature readouts: Display set value (for 2
seconds)

Reset: In order to reset the controller to the default setting,
keep the button pressed while defining the operating
voltage (display "EE") All user values will be lost during this
procedure! For this reason, please take a note of your own
parameters in this manual.

Settings via DIP switch (rear side)

- 1: no function in V1
- 2: no function in V1
- 3: no function in V1
- 4: no function in V1
- 5: no function in V1
- 6: Sensor selection: 5K NTC <-> 1K PTC

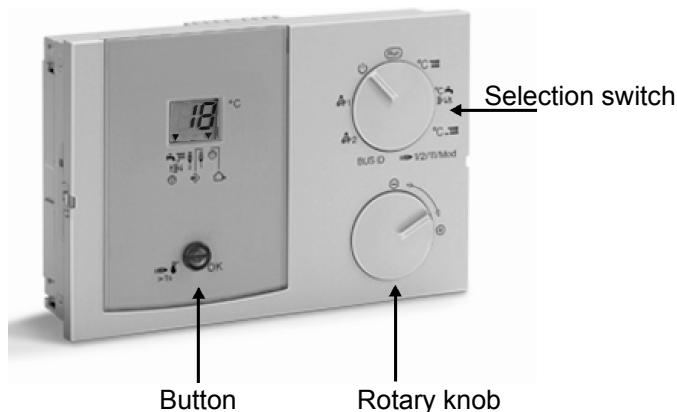

Display (normal mode "Run")

The display shows the flow temperature of the heat generator. When the rotary knob is rotated, the following temperatures are displayed:

- 1. - - (⊠, arrow 1)
- 2. Return flow temperature (⊠, arrow 2)
- 3. HS2 temperature (⇒₂, arrow 3),
- 4. Communication (⊠, arrow 4; --/0n)
- 5. Outside temperature (⊠, arrow 5)

Display "- -" => No measured value available.

If an arrow points towards one of the printed symbols in the standard display, the corresponding function is active.

Symbols below the display with return flow temperature increase

With return flow temperature increase sensor and mixer dynamic > --

- ⊠ // ⊠↑ // ⊠ = Mixer OPENS (arrow points upward)
- ⊠ ↓ // ⊠ = Mixer CLOSSES (arrow points downward)

With return flow temperature increase sensor and mixer dynamic > --

- ⊠ ↓ // ⊠ = Return flow temperature increase pump ON (arrow points downward)

Symbols below the display => 1 heat generator

- ⊠ // ⊠↑ // ⊠ = Mixer OPENS
- ⊠ ↓ // ⊠ = Mixer CLOSSES or return flow temperature increase pump ON
- ⊠ = HS pump ON
- ⇒₁ = Burner stage 1 ON
- ⇒₂ = Burner stage 2 ON

Symbols below the display => 2 heat generator [11]

- ⊠ = HS1 pump ON
- ⇒₁ = HS 1 ON
- ⇒₂ = HS 2 ON

Mixer dynamic > -- _____ = --

- ⊠ // ⊠↑ // ⊠ = Mixer OPENS // HS2 pump ON
- ⊠ ↓ // ⊠ = Mixer CLOSSES // return flow temperature increase pump ON

! Arrow points to symbol => associated function is active

Starting up

After the device has been properly installed, switch on the power supply.

The software number for your device and then the index of your software briefly appears in the display. Then the readout appears in accordance with the position of the selection switch.

The controller is now operational => "Run"

Modifying set values

Rotate the selection switch to the corresponding set value

The display shows the currently set value.









Press the OK button.

The value now starts to flash and can now be changed by means of the rotary knob (only if a modification is possible and permissible).

By pressing the OK button once more, the value is stored in the device.



Rotate the selection switch to RUN Automatic mode => the mode is activated after 2 seconds.

List of the User Set Values

<u>Designation</u>	<u>Area</u>	<u>Factory</u>	<u>IV</u>
Run => Normal mode	--		
Display level with rotary knob			
°C  (Max T-Boiler= 95°C) = with fixed value => Flow /Return flow set temperature*)	20°C - 110°C	40°C	
Cascade: Max T-Boiler	Display only		
°C  = during hot water operation:HW set temperature	No function	--	
  = with return flow temperature increase via Mixer and Mod: Mixer dynamics	--, 01K – 25K	-- (12K)	
With modulation in cascade: Activation time of the air damper	0s – 60s	20s	
°C  = in the case of return flow temperature increase: min. return flow temperature	10°C - 80°C	30°C	
 => 1/2/11/Mod = Heat generator stages	1/2/2A/11/m	2	
BUS ID = Bus identification / Heat generator number	-01, 01 – 08 11-88	01	
 #1 Service 1 / Emerg-Mode + Prog-button = Relay Test	00 – 05 00 = OFF 01-05 (see display symbols)	00	
 #2 Service 2 (see Selection switch)	--		
 Standby (OFF)	--		

Set values**°C  Flow set temperature (fixed value)**

Display of the maximum flow temperature
Without BUS: Input or the desired flow temperature.

°C  Return flow temperature increase (only with sensor )

Here the minimum return flow temperature for the heat generator can be entered.

With a pump-controller return flow increase, the mixer dynamic must be set to "—" The pump comes on if the min. return temperature is too low.

The pump is switched off if the return flow temperature exceeds the limit by 5K.

In the case of a return flow temperature increase via mixer, the mixer on the return flow sensor will regulate the temperature to the value set here.

  Mixer dynamic (for return flow temperature increase)

Speed setting at which the mixer motor adjusts when a control difference occurs. The control difference at which the mixer motor opens/closes without interruption is entered in Kelvin.

Standard value "—" => No mixer but return flow temperature increase pump. The setting 12 (12K deviation = 100% ID) cannot be used for most mixer motors.

! Small values cause the mixer to adjust quickly and can lead to oscillation.

Modulation ($\Rightarrow 1/2/11/Mod = m$)

Stand-alone or individual heat generators => Mixer dynamics for air damper control

Cascade => Setting the activation time [s] of the air damper from CLOSE to OPEN position (info on type plate).

 **1/2/11/Mod** Heat generator stages

1 = single stage heat generator

2 = 2-stage heat generator

2A = 2-stage heat generator

(only in the case of KM2 replacement)

11 = two single-stage heat generators

m = (Mod) modulating heat generator (air damper)

BUS-ID (number of the heat generator)

[-01] = Heating module address 1 with boiler set value specifications from Manager (from individual switching heat generators or individual heat generators modulated via air damper control))

[01 - 08] [11-88] If used as a heat generator in a cascade => Enter number of the heat generator. Settings >08 are only supported when corresponding cascade managers are used for connecting cascades.

! If two heat generators [11] are set, the second heat generator is assigned the address [BUS-ID + 1].
If KM2 replacement [2A] is set, the second burner stage is assigned the address [BUS-ID + 1].

Settings via DIP switch (rear side)

! Settings 1-5 => In V1 without function

Sensor selection (5K NTC <-> 1K PTC)

Check the installed sensors (imprint, type plate, or measurement value - see table) and set the switch accordingly.

Functions

! In V1, only stand-alone operation and operation with a cascade controller/manager is supported (also applies to individual heat generators).

Operation in the cascade

Function only with cascade manager via CAN BUS

Settings:

1/2/11/Mod = Depending on heat generator
BUS-ID = 01-88 (cascade)

Settings on the cascade controller:

HS1 Type = Cascade modulating or switching
HS1 BUS = CAN BUS

The controller can be used as a heating module for the operation of switching and modulating (air damper) oil or gas heat generators in cascades with 1 to 8 heat generators (or 09-64 heat generators; only with corresponding cascade managers). The controller can be

used to actuate any of the following configurations:

- A single stage heat generator with associated boiler pump and return flow temperature increase via pump or mixer (1/2/11/Mod =1)
- A two-stage heat generator with associated boiler pump and return flow temperature increase via pump or mixer (1/2/11/Mod =2)
- A two-stage heat generator with associated boiler pump and shared return flow temperature increase via pump or mixer (1/2/11/Mod =11)
- A modulating heat generator with associated boiler pump (1/2/11/Mod =m)

Modulation in the cascade

In the case of a cascade, an air damper position is assigned to the required degree of modulation. The air flap is driven for the defined activation time => The mixer OPEN/CLOSE relays (here air damper connection) are actuated for the calculated period. => Only one qualitative control process is performed (more/less output). The heat generator will not deliver the exact degree of modulation required.

! The air damper activation time must be set under switch position "☒ ".

Air damper position:

0-10% = CLOSE; 100% = OPEN; Intermediate values in increments

Operation of a single heat generator

Settings:

1/2/11/Mod = m (Modulation)

1/2/11/Mod = 1 (switching heat generator)

BUS-ID = -1 (single HS with desired temperature presetting)

Settings on the Manager/Cascade controller:

HS1 Type = Single stage HS switching!

HS1 BUS = CAN BUS

Stand alone

The heat generator is activated once the temperature drops below the set temperature.

Deactivation occurs at T-Des + 5K.

Modulation: The mixer relays regulate the desired temperature of the heat generator by adjusting the air damper.

Single HS with Manager via CAN BUS

The burner is switched according to Manager presettings

Modulation: The mixer relays regulate the temperature at Sensor T-BOILER to the value T-BOILER DES preset in the Manager.

Modulation via air damper

The initial damper adjustment occurs with a delay of approx. 3 minutes after a burner start. While "Burner OFF"

and during the first three minutes after "Burner ON", the air damper is constantly driven towards in "CLOSE" direction.

Connection

During this operating condition, the relays T3 T4 is switched in parallel with the HS pump => When the HS provides the potential (L1') for the air damper relays, it is connected to the terminal L1' on the controller. The HS pump is then connected to T3 (= pump phase and bridge T4 to power supply phase L1). The air damper for modulation is connected to the contacts 5 (OPEN), 6 (CLOSE) and 8 (potential).

- Enables burners 1+2
- 5+6+8 air damper (N = 10)
- > 5= Damper OPEN (warmer)
- > 6= Damper CLOSE (colder)
- > 8= Supply for damper
- 11 HS pump (N = 10)
- 9+12 Bridge (supply for HS pump)

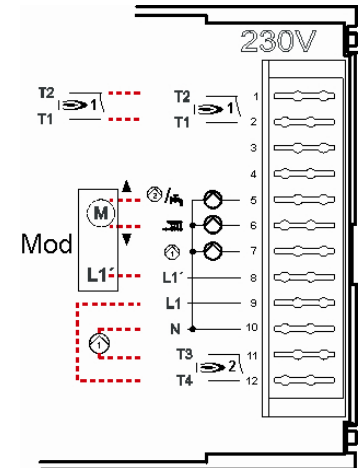

Frost protection function

The frost protection circuit prevents the heating system from freezing by automatically switching on the pump.

Flow sensor frost protection

The frost protection function is activated if the flow temperature drops below 7°C.

The frost protection function is deactivated if the flow temperature rises above 9°C.

Outdoor sensor frost protection

The frost protection function is activated if the outside temperature drops below 0°C. The pumps are activated and the burner is enabled.

Temperature monitor operation

The boiler pump runs continuously if boiler max. has been reached. Deactivation with 5k hysteresis.

Pump-controlled return flow temperature increase

ON: Return flow temperature < Minimum return flow temperature

OFF: Return flow temperature > Minimum return flow temperature + 5K or burner OFF.

Mixer-controlled return flow temperature increase

Mixer CLOSE = Heat is transported into heating system:
Return flow temperature > Minimum return flow temperature.

Mixer OPEN = Short circuit/blocking of generator:
Return flow temperature < Minimum return flow

temperature or [burner OFF and after-run time of pump has elapsed].

EEPROM check

Every 10 minutes, a check is conducted automatically in order to establish whether the settings of the controller lie within the specified limits. If a value is found to be out-of-range, it is substituted by the related default value. The range transgression is indicated by the flashing error number 81.

In this case, the user should check the important settings of the controller. The error indication symbol goes out after the unit is restarted (RESET).

Pump blocking protection

The controller effectively prevents the pumps blocking following longer periods out of operation. The integrated protection function activates for 5 seconds all pumps that have not been in operation during the past 24 hours.

Mixer motor blocking protection

If the mixer was not moved for 24 hours, it is fully opened once only. The heating circuit pump is switched off during this time. The maximum flow temperature is monitored. Cancelled at maximum flow temperature – 5K.

Delayed pump switch-off

When a heat generator is shut off the assigned pump runs on for 5 minutes. The return flow temperature increase pump is shut off immediately.

Installation

Assembly / Dismantling

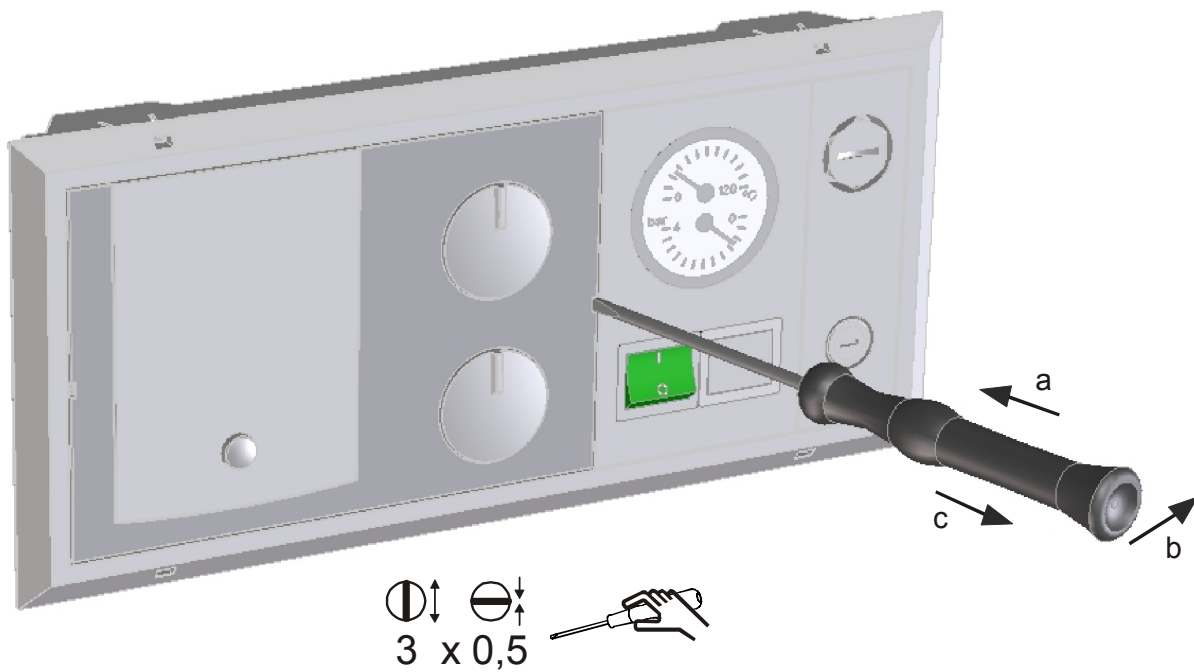

Electrical connection Controller

230V~; Relay switching capacity 2(2)A, 250V~

Safety extra-low voltage

13-16 CAN BUS

17+18 Sensor for HS2
(= Boiler 2) KF2
alternatively:

19+20 Return flow
sensor VF
only in the case of return
flow temperature
increase

22+23 Sensor for HS1
(Boiler1) KF1

24+25 Outdoor sensor
(frost protection only)

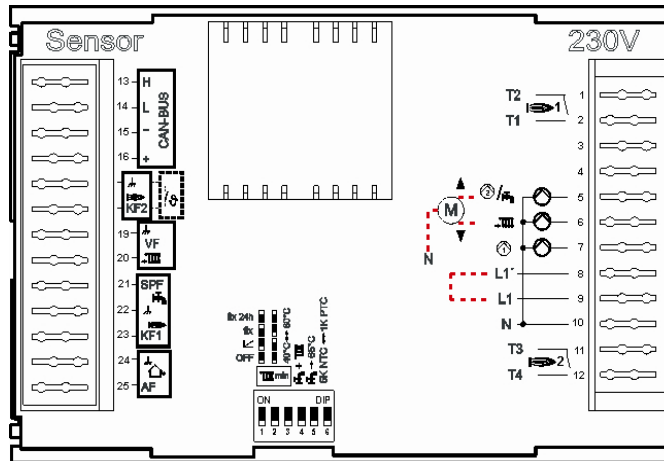

1+2 Burner 1 (floating contact)

5 Mixer OPEN /
HS2 pump

6 Mixer CLOSE /
Return flow temperature increase
pump

7 Pump heating circuit / HS /
Collector

8 L1 Power supply, relay

9 Power supply, device

10 N-conductor, mains

11+12 Burner 2 / Stage2 (floating
contact); Potential for example with
bridge 11 to 9

⚠ Attention: For the connection (230 V) fixed or flexible lines with the factory-standard lead end sleeves are to be installed.

⚠ The controller is designed for an operating voltage of 230 V AC at 50 Hz. The burner contact is a floating contact and must always be connected in series with the mechanical boiler thermostat.

⚠ Attention: Bus lines and sensor lines are to be installed separately from supply lines!

! Switches 1-5 are always without function in this version. Switch 6 must be used to set the sensor type!

System diagrams

HS controller in cascade operation

- A Heat generator with temperature sensor KF and switch input T1 T2
- B HS pump (possibly in heating circuit flow)
- C Return flow sensor VF
- D Mixer (Temperature increase of return flow by mixer)
- E Pump (Temperature increase of return flow by pump)

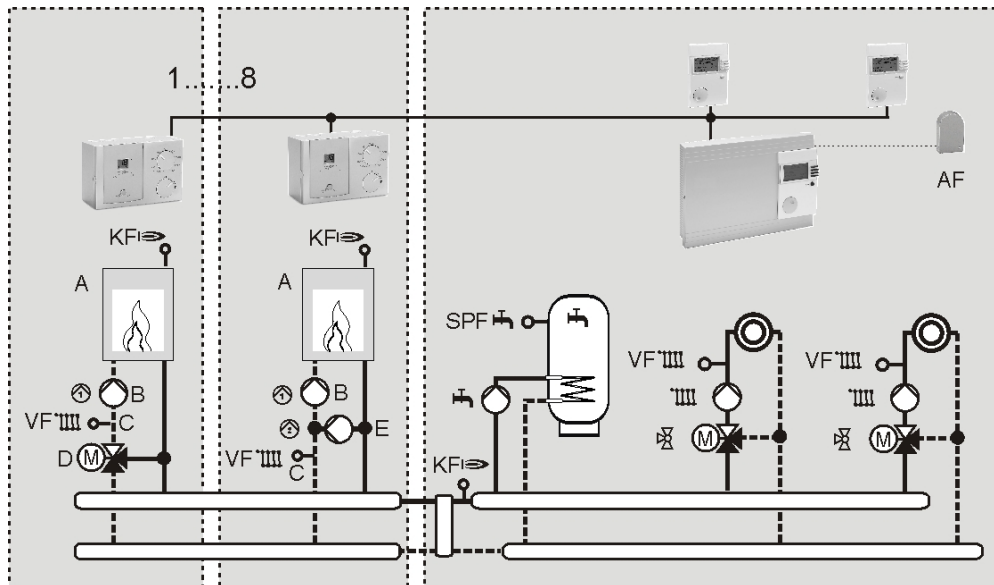
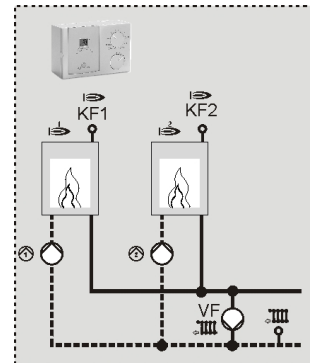

Sensors

Outdoor sensor AF

Installation location:

- Wherever possible, on a northerly or north-easterly wall behind a heated room
- Approx. 2.5 m above ground
- Not above windows or ventilation shafts

Installation:

- Detach the cover
- Attach the sensor with the supplied screw



Immersion sensor KF / SPF

Installation location:

- In the immersed pipe of the hot-water cylinder tank (generally on the front face of the tank)

Installation:

- Slide the sensor as far as possible into the immersed pipe.

! The immersed sleeve must be dry.



Flow sensor VF

Installation location:

- In the case of boiler control instead of the boiler sensor KF as close as possible behind the boiler on the heating flow pipe
- In the case of mixer operation  approx. 0.5 m behind the circulation pump

Installation:

- Thoroughly clean the flow pipe.
- Apply heat conductive paste (A)!!
- Secure sensor with stretch band.

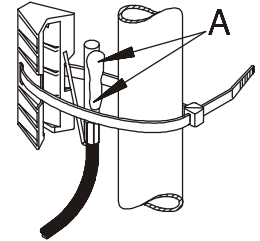

00980-01

Sensor values / characteristic curve

Temperature	5Kohm NTC	1Kohm PTC
-60°C	698961 Ω	470 Ω
-50°C	333908 Ω	520 Ω
-40°C	167835 Ω	573 Ω
-30°C	88340 Ω	630 Ω
-20°C	48487 Ω	690 Ω
-10°C	27648 Ω	755 Ω
0°C	16325 Ω	823 Ω
10°C	9952 Ω	895 Ω
20°C	6247 Ω	971 Ω
25°C	5000 Ω	1010 Ω
30°C	4028 Ω	1050 Ω
40°C	2662 Ω	1134 Ω
50°C	1801 Ω	1221 Ω
60°C	1244 Ω	1312 Ω
70°C	876 Ω	1406 Ω
80°C	628 Ω	1505 Ω
90°C	458 Ω	1607 Ω
100°C	339 Ω	1713 Ω
110°C	255 Ω	1823 Ω
120°C	194 Ω	1936 Ω

Errors

When there is an error, the corresponding error number flashes.

Error no.	Error description
Communication error	
E 91	Bus ID used. The set bus ID is already in use by another device.
Internal error	
E 81	EEPROM error. The invalid value has been replaced with the default value ⚠ Check parameter values!
Sensor defective (break/short circuit)	
E 70	Flow sensor
E 75	Outdoor sensor
E 76	Storage tank sensor
E 77	Boiler sensor
E 80	Room sensor

Resetting error number 81:
Switch mains voltage Off and On again.

Technical data

Supply voltage complying with DIN IEC 60 038	230 V AC ± 10%
Power consumption	Max. 5 VA
Switching capacity of the relays	250 V AC 2(2) A
Switching capacity Triac (T3/T4)	250V AC 1,2(1,2) A
Maximum current on terminal L1'	6.3 A
Type of protection complying with DIN EN 60529	IP 40
Protection class complying with DIN EN 60730	Totally insulated
Permitted ambient temperature during operation	0 to 50°C
Permitted ambient temperature for storage	-20 to 60°C
Permissible humidity non condensing	%95 r.H.
Sensor resistances	NTC 5 kΩ (AF,KF,SPF,VF)
Tolerance in ohms	+/- 1% at 25°C
Temperature tolerance	+/- 0.2K at 25°C
	PTC 1010Ω (AFS,KFS,SPFS,VFAS)
Tolerance in ohms	+/- 1% at 25°C
Temperature tolerance	+/- 1.3K at 25°C

Malfunctions due to improper operation or settings are not covered by the warranty.